

## KISSLING SINGLE POLE POWER RELAYS

### Series 29 / 300 A

The economical 29 series single coil relays with 300 A are developed using our competence and expertise gathered over decades of manufacturing to meet even the most demanding operating requirements.

This single coil system relay features high shock and vibration resistance predominantly from its careful design and an optimized magnetic circuit. The sealing technology used in these relays meets both the IP67 and IP6K9K (steam pressure cleaning) protection standard. This relay series is well suited for various applications in severe conditions.

Other important advantages are low heat generation in the contact area based on low contact voltage drop, a compact design, low holding current, silver alloy contact material and the use of mechanical and high thermal stability insulating compounds. Both the terminals and the housing are protected against corrosion.

By equipping these relays with blow-out magnets, contact voltages are also achievable up to 250 VDC. The use of blow-out magnets are also recommended for contact voltages over 40 VDC and for inductive load applications to maintain long contact life at all voltages.

Also available are various bracket styles to meet your installation conditions and suppression devices to eliminate electromagnetic interference at the coil and optional auxiliary contacts.

### FEATURES

- Sealed housing meets IP67 and IP6K9K
- Robust design
- Minimized coil current
- Variety of configuration options
- 6G shock and 4G vibration resistant
- Main contact current rated for continuous current and 100% duty cycle
- Efficient coil and magnetic circuit design with switching properties and holding current requirements

### APPLICATIONS

- Truck
- Bus
- Ground support vehicles
- Construction and agricultural vehicles
- Fork lift applications

# KISSLING SINGLE POLE POWER RELAYS

Series 29 / 300 A

## CIRCUITS

NO-Contact

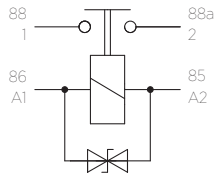

Suppression diode

NC-Contact

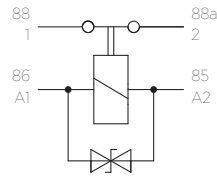

Suppression diode

NO/NC-Contact

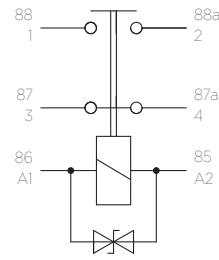

Suppression diode

NO-Contact/Auxiliary-Contact

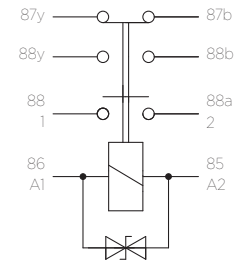

Suppression diode

## SPECIFICATION

| Technical Data        |  |
|-----------------------|--|
| Temperature range     | -40°C to +85°C   |
| Protection            | IEC 60529 & DIN 40050-9 - IP67 (0,2 bar, 1 min) and IP6K9K |
| Shock                 | 6G / 11 msec   |
| Vibration             | 4G / 50-2000 Hz  |
| Thread sizes / Torque | M4 = 2.0 - 2.2 Nm   M10 = 15 - 20 Nm                       |

| Electrical Characteristics      |                                 |
|---------------------------------|---------------------------------|
| Min. Insulation resistance      | 100 MΩ                          |
| After live or environment       | 50 MΩ                           |
| Dielectric withstanding voltage | 1050 VAC / 1 min at 50 Hz       |
| Max. Contact drop, initial      | 150 mV                          |
| Contact drop after life test    | 175 mV                          |
| Continuous current              | 300 A                           |
| Overload                        | 2400 A - 1 sec / 600 A - 20 sec |

| Rated contact load | 12 / 24 / 28 VDC | 48 VDC           | 60 VDC           | 80 VDC           |
|--------------------|------------------|------------------|------------------|------------------|
| Resistive load     | 300 A            | 300 A            | 300 A            | 200 A            |
| Cycles             | 200.000          | 100.000          | 50.000           | 100.000          |
| Mechanical life    | 2.000.000 cycles | 2.000.000 cycles | 2.000.000 cycles | 2.000.000 cycles |

## KISSLING SINGLE POLE POWER RELAYS

Series 29 / 300 A

| Coil Data             | 12 VDC     | 24 / 28VDC | 48 VDC      | 60 VDC      | 80 VDC      |
|-----------------------|------------|------------|-------------|-------------|-------------|
| Voltage range         | 9-16 VDC   | 18-32 VDC  | 36-54 VDC   | 45-68 VDC   | 60-90 VDC   |
| Nominal voltage       | 12 VDC     | 28 VDC     | 48 VDC      | 60 VDC      | 80 VDC      |
| Pick up voltage max.  | 9 VDC      | 18 VDC     | 36 VDC      | 45 VDC      | 60 VDC      |
| Drop out voltage min. | ≤ 2 VDC    | ≤ 4 VDC    | ≤ 8 VDC     | ≤ 10 VDC    | ≤ 20 VDC    |
| Coil resistance       | 15 Ω ± 10% | 62 Ω ± 10% | 245 Ω ± 10% | 370 Ω ± 10% | 660 Ω ± 10% |
| Coil current approx.  | 1 A        | 0.40 A     | 0.20 A      | 0.18 A      | 0.12 A      |
| Coil power approx.    | 10 W       | 10 W       | 10 W        | 10 W        | 10 W        |

| Operating times NO-Contact relay |   |
|----------------------------------|---|
| Operate                          | max. 40 msec                                      |
| Bounce                           | max. 5 msec                                       |
| Release                          | max. 20 msec                                      |
| Wire Section                     | min. 95 mm <sup>2</sup> / 0.147 sq.inch / AWG 4-0 |
| Mounting position                | optional  |

**TECHNICAL DRAWINGS**

Standard side mounting

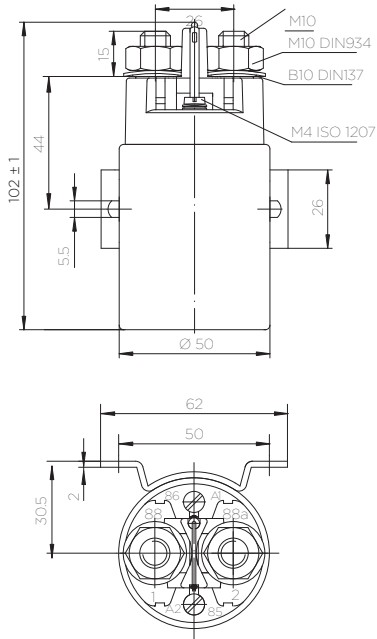

Short form side mounting

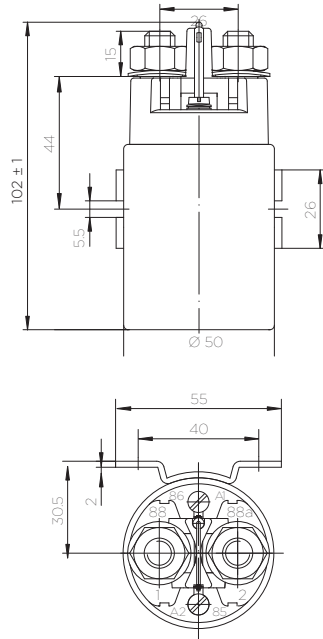

Long form side mounting

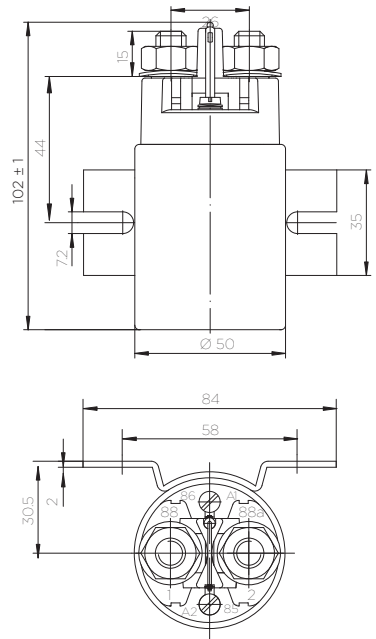

Bottom mounting

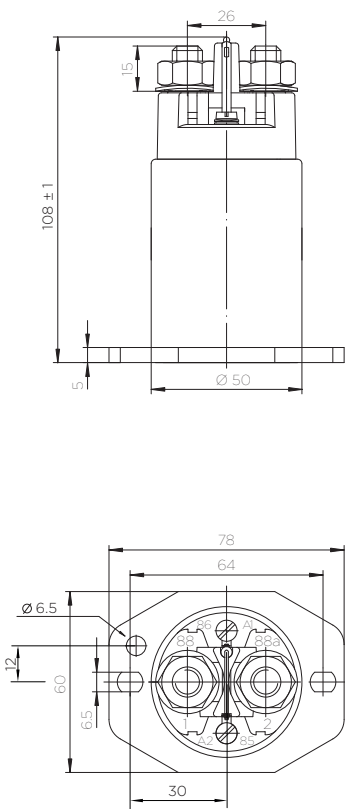

Change-over NO/NC

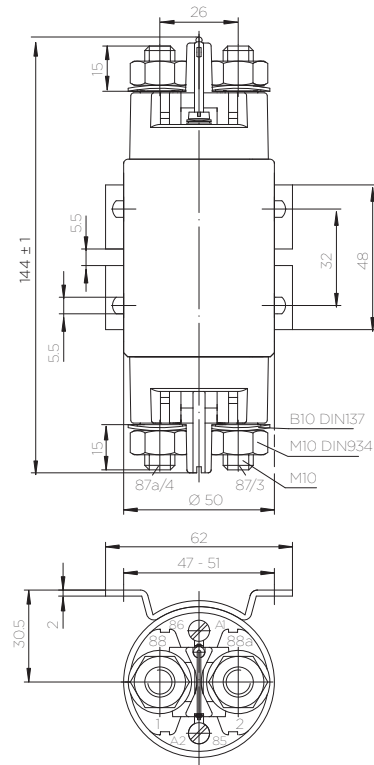

Options:

Auxiliary contacts, magnetic blowouts

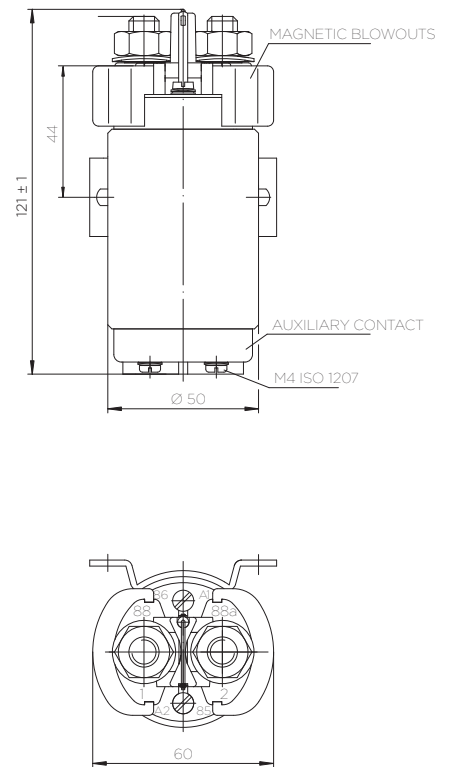

# KISSLING SINGLE POLE POWER RELAYS

Series 29 / 300 A

## ORDERING INFORMATION

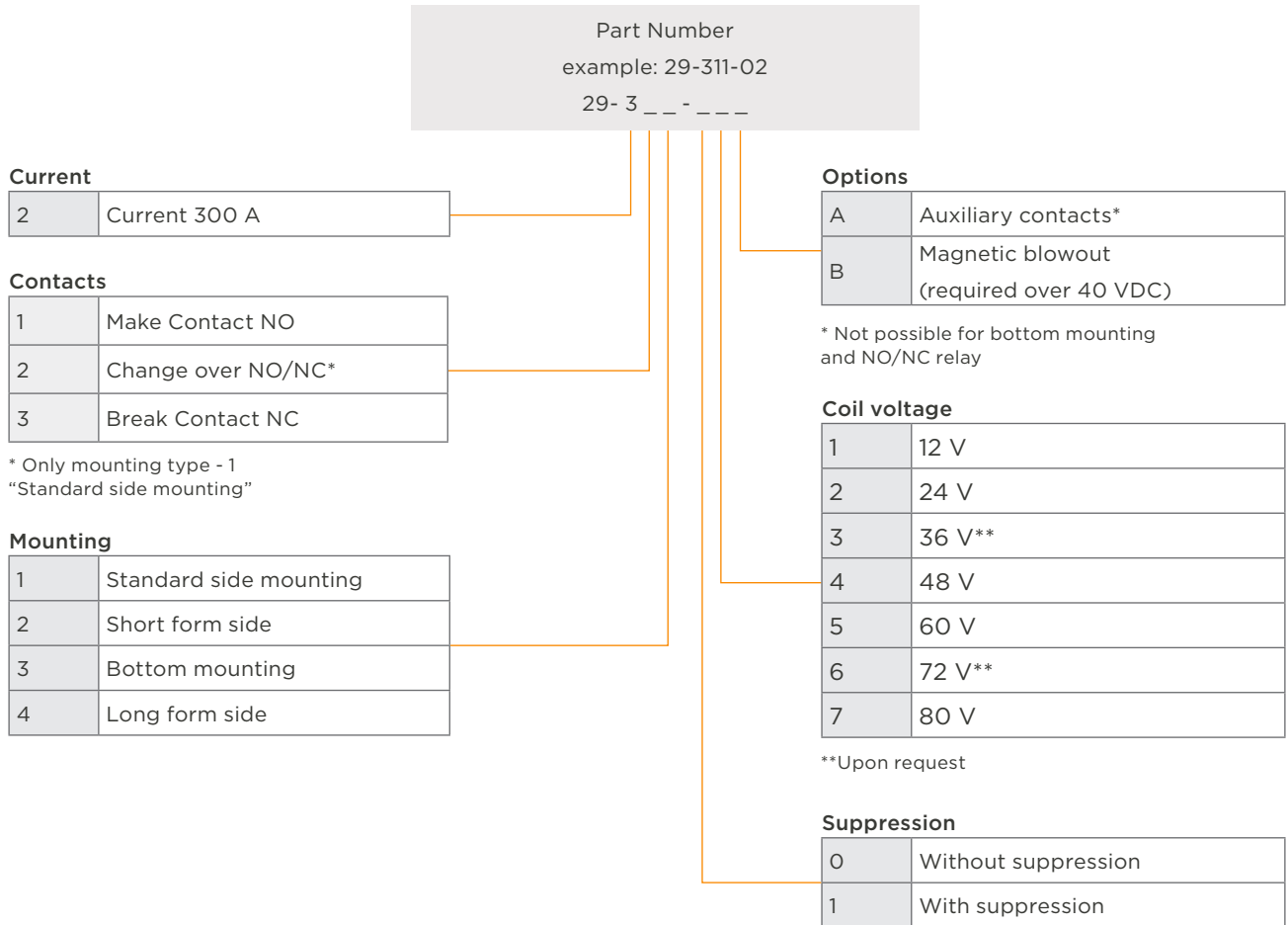

## te.com/KISSLING

© 2023 TE Connectivity. All rights reserved.

KISSLING, TE, TE Connectivity, and TE connectivity (logo) are trademarks owned or licensed by the TE Connectivity Ltd. family of companies. Other logos, product(s) and/or company names might be trademarks of their respective owners.

TE Connectivity's (TE's) only obligations are those stated in TE's General Terms and Conditions of Business ([www.te.com/aboutus/tandc.asp](http://www.te.com/aboutus/tandc.asp)). While TE has made every reasonable effort to ensure the accuracy of the information in this catalog, TE does not guarantee that it is error-free, nor does TE make any other representation, warranty or guarantee that the information is accurate, correct, reliable or current. TE reserves the right to make any adjustments to the information contained herein at any time without notice. TE expressly disclaims all implied warranties regarding the information contained herein, including, but not limited to, any implied warranties of merchantability or fitness for a particular purpose. The specifications in this catalog are for reference purposes only and are subject to change without notice. Consult TE for the latest dimensions and design specifications.

Published 11-2023